

easee

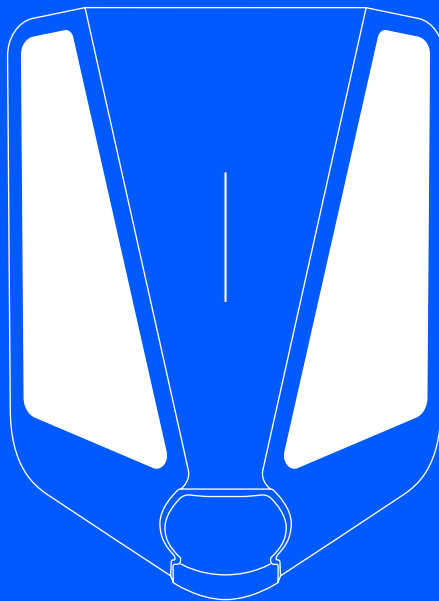

EN User guide

# Easee Charge Pro Eichrecht

# How do I charge?

Read the Important product information guide in the product packaging or at [support.easee.com](https://support.easee.com) before using the product.

Installation and operation of the product requires a mobile device with internet or Bluetooth connection.

Make sure that the following requirements are met before using the charger:

- The product and its electrical connection has been installed by an authorised electrician according to the Installer guide.
  - The charger is properly configured.
  - The software is up to date (see the [Charger interface](#)).
  - If you have set up access control, unlock it by using a registered RFID tag (see the [Features](#)) or disable it from the Easee App or the local interface.
1. Check the charging cable and connector for damage and impurities such as foreign objects and water ingress before charging.
  2. Connect the charging cable to the charger and your electric car. The charging process starts and adapts automatically to the electric car and the available energy at any time according to the configuration.

If you have set charger access to either Private or Public in the app, you will need to use your RFID tag or the app to identify yourself and start the charging session. If the access is set to Open no identification is necessary to start a charging session.

If the car does not start charging, check that charging is activated in your car and that the connectors are properly plugged in. If charging still does not start, check what might be the cause on the [Charger interface](#) section.

## Smart charging

Some operators offer smart charging which will delay charging to a suitable point in time, often tied to electricity price or similar mechanisms. When Smart charging is active the LED strip is lit blue, and charging will not start until the operator's criteria for charging is met. Contact you operator to know more and to find out if they offer this service.

## Manufacturing Date and Serial Number

The Chargeberry's month and year of manufacture and serial number are on the sticker on the Type-2 socket underneath the charger cover. The production date is displayed in MM/YY format, directly above the serial number, unique to each Chargeberry unit.

The manufacturing date can be found in DD/MM/YY format in the user app. Go to Charger settings, then About, then Manufactured.

## Data Protection

Upon Installation and connection to the internet, as an IoT device Easee chargers automatically share data with the Easee cloud (owned by Easee). This makes sure that Easee monitors the charger safety, security, and stability during its lifetime. As a result, some personal data, such as usage patterns, site configurations, and device identifiers, will be processed to provide the smart functionalities of the charger. By using our Chargers, you agree to the collection and processing of some personal data in line with our privacy policy and any applicable data protection laws. If data transfer to the Easee cloud is not desired, we advise users to stop using Easee chargers immediately. For more information, please see Easee Privacy Policy (<https://easee.com/en/privacy/>), available in our website.

## Notes

- Type designation: Easee AC Charger Platform CB-A3-3
- The operating temperature of the charger is from -30 °C to +40 °C
- The metering temperature range is from -40 °C to +55 °C

# Apps and interfaces

## Easee App

The Easee App gives full control and status over your charger. It's intended for everyday use of your Easee products, through the Easee Cloud.

To download the app, scan the QR code or go to:  
[easee.com/app](https://easee.com/app)



## Local interface

The local interface is intended for local operations of the charger when no internet is available.

Read more about the local interface at:  
[easee.com/support/bt](https://easee.com/support/bt)

## Easee Control

Easee Control is a tool intended for administration of one or several Easee sites. Control is mainly for site owners, installers, administrators, service providers and people who need to manage several products and sites from one interface.

Go to [support.easee.com](https://support.easee.com) for more information on our interfaces.

## Measuring instruments (MID)

Measuring instruments produced according to EN 50470-1 / EN 50470-3.

The MID meter display is located on the right side of the Chargeberry. To access the display, open the front cover by inserting the front cover tool into the two openings at the bottom of the cover and pulling it so that the cover comes loose.

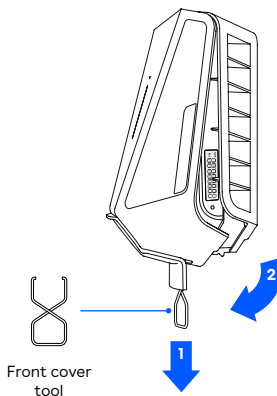

# Features

## Front view

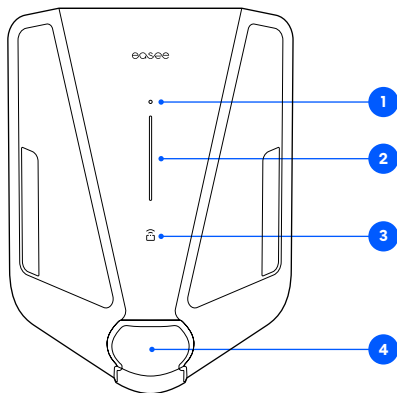

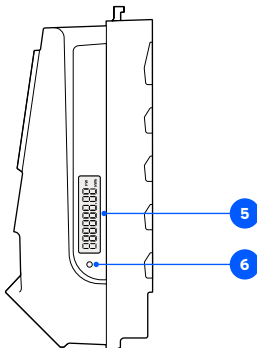

## Side view Chargeberry



1. **Touch button:** The touch button is used to turn on the MID meter display light, and to activate Bluetooth. Press for 1 s to turn on the light, press for 5 s to start Bluetooth. Bluetooth connection in the app allows for local operation of the charger when no internet is available. Read more about the Bluetooth interface at: [easee.com/support/bt](https://easee.com/support/bt)
  2. **Light strip:** The light strip communicates the status of the charger at all times. (See [Charger interface](#)).
  3. **RFID area:** The integrated RFID reader enables access control of the charger and identification of different users. You can use it to unlock the charger with an Easee Key. Check our knowledge base at [support.easee.com](https://support.easee.com) for more details on how to add and manage your Easee Keys.
  4. **Type 2 socket:** The Type 2 socket is completely universal and allows you to charge any type of electric vehicle using the appropriate charging cable. Furthermore, it is possible to permanently lock the charging cable, so you do not have to worry about it being stolen.
- NOTE:** Adaptors should not be used on the charger or the charging cable. The charging cable must have appropriate sockets on each end.
5. **MID meter display:** The MID meter display shows the cumulative energy in kilowatt-hours (kWh).
  6. **Infrared (IR) LED:** Pulses with IR light indicating the energy transfer by the charger.

# Charger interface









Light description	Status
White - constant light, only at the bottom 2 LEDs - master unit / 1 LED - secondary units	Standby
White - constant light	Car connected
White - pulsating light	Charging in progress
Blue - constant light	Smart charging enabled (car connected)
Blue - pulsating light	Smart charging in progress
At startup, the LEDs turn on one by one. When the charger is updating, one or more LEDs will flash green while this is in progress.	Updating software (updating can take up to 15 minutes) <b>NOTICE!</b> The car must be disconnected before a software update can be completed.
White - flashing light	Waiting for authentication by an RFID tag. Hold the RFID tag against the RFID area of the charger in order to authenticate and initiate the charging.
White - fast flashing light	RFID-tag received (awaiting key verification)
Red - flashing light, with warning sounds	 <b>WARNING</b> Critical error! Turn off the power and remove the charging cable from the charger. The power can then be turned back on if necessary. The flashing red light will continue, but the warning sound will stop when the charging cable is disconnected. The charger is blocked from further use, cannot be reset and has to be replaced. Contact customer support.
Red - flashing light	 <b>WARNING</b> Critical error! The charger is blocked from further use, cannot be reset and has to be replaced. Contact customer support.
Red - constant light	General error. Unplug the charging cable and replug it to the charger. If the red light persists, check the Easee App or our knowledge base <sup>1</sup> for further information.
Red - constant light, with warning sounds	Wires are connected incorrectly. Consult an authorised electrician.



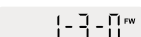
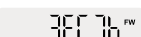

<sup>1</sup> Easee public knowledge base can be found at [support.easee.com](https://support.easee.com).

Light description	Status
Red - pulsating light	The charger has measured an abnormal temperature and has entered in safe mode. Please go to our knowledge base <sup>1</sup> for further information.
White - flashing light, only at the bottom	The charger is searching for its master unit. Please check the status of the master unit. For further information, please check our knowledge base <sup>1</sup> .
Yellow - flashing light, only at the bottom	The charger is waiting to be configured. Consult an authorised electrician.

<sup>1</sup>Easee public knowledge base can be found at [support.easee.com](https://support.easee.com).

# MID display interface

Status	Description	Screen
<b>Boot sequence</b>	1. All segments on, for 1 s	
	2. Vertical segments and kWh segment, for 1 s	
	3. Horizontal segments, decimal point and FW segment, for 1 s	
	4. Scrolling "EASEE", for 4 s	
	5. Firmware semantic version (major-minor-patch), for 20 s	
	6. Firmware unique value (16-bit CRC in hexadecimal), for 20 s	
	7. Normal standby mode sequence	
<b>Normal standby mode sequence</b> <i>Cable not connected, not charging</i>	1. Accumulated import energy, for 10 s	
	2. Accumulated export energy, for 10 s <i>Identified by '-' sign character</i>	

Status	Description	Screen
Charging session open	Net Session Energy <i>Digits only denotes net energy is import</i>	
	Net Session Energy <i>'-' sign denotes net energy is export</i>	
Cable connected, not charging	The three segments at the end blink on and off.	
Drawing current, charging	The three segments at the end light sequentially, from 0 to 3. This mimics the image of a charging battery. The sequence is reversed for energy export.	

# MID display light function

Status	Tap Touch Button
<b>No car connected</b>	Display lights up for 20 s Accumulated energy total is displayed
<b>Charging session open</b> <i>Cable connected, not charging</i>	Display lights up Session energy displays for 15 s Accumulated energy displays import for 5s, then export for 5s (Display automatically lights for 9 s showing accumulated energy when a charging session starts)
<b>Charging session open</b> <i>Drawing current, charging</i>	Display lights up Session energy displays for 15 s Accumulated energy displays import for 5s, then export for 5s

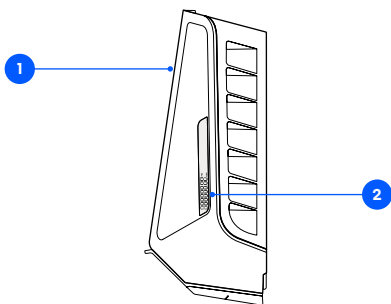

- 1. Touch button:** The touch button is used to turn on the MID meter display light. Touch for 0,5 to 1 s to turn the MID meter display light on.
- 2. MID meter display:** The MID meter display shows the cumulative energy in kilowatt-hours (kWh).

# Eichrecht

**Easee Charge Pro Eichrecht fulfills the requirements of Eichrecht (MessEV/MessEG), the German framework for calibrated and tamper-proof energy measurement.**

The charger contains a certified energy meter that precisely records the delivered energy (kWh) and makes this information available to the user.

**Validity of the certificate:** 23. Januar 2036.

All measurement data is digitally signed and encrypted before being sent to external systems. This prevents tampering and ensures that consumption data remains accurate for fair and compliant billing.

In accordance with Eichrecht requirements, at least one method for independent verification of session data must be available to the user. This can be provided through a transparency software solution (e.g. S.A.F.E.) that enables access to the original signed measurement data.

## Important notice

In rare cases, measurement data for a charging session may not be verifiable by third-party transparency software if a power interruption occurs during charging and the vehicle is disconnected before the power supply is restored. In such cases, the measured session energy remains valid, but the transparency verification process may be affected.

Further legal requirements and information regarding compliance with German Calibration Law can be found in our [knowledge base](#).

## Verify measurement data in Easee Portal

1. Log in to [portal.easee.com](https://portal.easee.com).
2. Locate the charging site.
3. Under "consumption", click the preferred charger.
4. Select the charging session you want to verify.
5. Retrieve the public key\* and signed session data in Open Charge Metering Format (OCMF) in the session summary panel.
6. The public key and signed session data can be validated by transparency software (e.g. S.A.F.E.).

## Verify measurement data in the Easee app

1. Open the app
2. Tap "charger consumption"
3. Select the charging session you want to verify
4. Retrieve the public key\* and signed session data in Open Charge Metering Format (OCMF) in the session summary panel.
5. The public key and signed session data can be validated by transparency software (e.g. S.A.F.E.).

\* *The public key is also provided on the charger as a QR code for independent verification (see illustration).*

For more information about Eichrecht and our interfaces, go to [support.easee.com](https://support.easee.com).

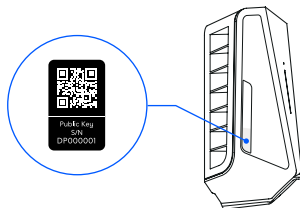

# Maintenance

## General maintenance

- Ensure that the charger does not have any signs of mechanical damage.
- Visually inspect the Type 2 socket for wear and tear at regular intervals according to local regulations. If the pins are discoloured or damaged, please contact your authorised electrician.

## Cleaning

The product does not require cleaning to operate properly. Nevertheless, if the product needs to be cleaned for cosmetic reasons, this is possible.

- Use a damp cloth and an all-purpose household cleaner. Avoid using strong chemicals that contain oil or alcohol, as this will discolour the plastic.  
**NOTICE!** Do not clean the screen with cleaner. Use a dry or damp microfiber cloth only.
- Do not use running water or high pressure water jets.

## Repair

If your charger needs to be repaired, please contact your Easee supplier.

## Returns and complaints

Contact your distributor or Easee Customer Support regarding the return and complaint of your product.

## Customer support

Download the latest manuals, find answers to frequently asked questions and useful documents and videos for your product at [support.easee.com](https://support.easee.com).

# Practical details

## Warranty

The device is free from material defects and is in accordance with laws and regulations for consumer protection in the country where the product is purchased. All correctly installed Easee hardware is covered by our 5 years\* limited warranty. If your charger needs to be repaired within this warranty period, please contact your Easee supplier. Further information can be found at [support.easee.com](https://support.easee.com).

\*Some countries may have extended warranty.

## Contact details

Easee IP AS  
Vassbotnen 23  
4033 Stavanger, Norway  
Org. nr: 920 292 046

You can find additional contact details for your country at [easee.com](https://easee.com).

The information in this document is for information purposes only, is provided as is, and may be subject to change without notice. Easee IP AS, including its subsidiaries, does not accept any liability for the correctness or completeness of the information and illustrations, and is not liable or responsible for your considerations, assessments, decisions or absence of such, or other use of the information in this document.

No part of this publication may be re-published, reproduced, transmitted or re-used in any other form, by any means or in any form, for your own or any third-party's use, unless otherwise agreed with Easee or its subsidiaries in writing. Any permitted use shall always be done in accordance with good practice and ensure that no harm may be caused to Easee or by misleading the consumer.

Easee and Easee products, product names, trademarks and slogans, whether registered or not, are Easee's intellectual property and may not be used without Easee's prior written permission. All other products and services mentioned may be trademarks or service marks of their respective owners.

March 2026 – Version 1.00

© 2026 by Easee IP AS. All rights reserved.



Easee IP AS  
Vassbotnen 23  
4033 Stavanger, Norway  
[www.easee.com](http://www.easee.com)